



NAZIVNI PROMJER NENNWEITE NOMINAL SIZE DN	NAZIVNI TLAK NENNDRUCK PRESSURE RATING PN bar	PRIRUBNICE FLANSCH EN 1092-2 (DIN 2501) bar	VODNI ISPITNI TLAK WASSERPRÜFD RUCK TEST PRESSURE bar		DOZVOLJENI RADNI TLAK KOD TEMPERATURE ZULÄSSIGER DRUCK BEI TEMPERATUR ADMISSIBLE PRESSURE AT TEMPERATURE	
			KUČIŠTE GEHAUSE BODY	ZATVORENO IM ABSCHLUSS CLOSED	TEKUĆINE DO 120°C	TEKUĆINE DO max 200°C
40 – 400	40	40	60	40	40	16
40 – 1000	25	25	40	25	25	16

Broj artikla
Artikelnummer
Model N°
V3 – 01/1

NAMJENA: VODA, PITKA VODA, PLIN, PARA I VRELA VODA, NAFTA, ZRAK
VERWENDUNG: WASSER, TRINKWASSER, GAS, DAMPF UND HEISSWASSER, ÖL, LUFT
APPLICATION: WATER, DRINKING-WATER, GAS, STEAM AND SUPERHEATED WATER, OIL, AIR

Ugradna mjera: DIN 3202 red F 15 (tvornički standard)

Baulängereihe: DIN 3202 Reihe F 15 (nach Werksnorm)

Face to face: DIN 3202 Series F 15 (factory standard)

ISPITIVANJE IZVRŠENO PREMA EN 12266 (DIN 3230)

FERTIGUNGSKONTROLLE NACH EN 12266 (DIN 3230)

TEST ACCORDING TO EN 12266 (DIN 3230)

Prirubnice izvedene za ugradnju prema EN 1092-2 (DIN 2501) ili na zahtjev prema DIMA 1882, UNI, BS, ANSI, NF

Einbaufflansche nach EN 1092-2 (DIN 2501) oder auf Anfrage nach DIMA 1882, UNI, BS, ANSI, NF. Installation flanges according to EN 1092-2 (DIN 2501) or on request according to DIMA1882, UNI, BS, ANSI, NF

Upravljanje ručnim kolom. Na zahtjev hidrauličko ili pneumatičko upravljanje, elektromotorni pogon, reduktor.

Handradbetätigung. Auf Anfrage hydraulische oder pneumatische Steuerung, Elektroantrieb, Reduktionsgetriebe.

Hand wheel operation. On request hydraulic or pneumatical actuation, electric actuator, gear-box.

POZ TEIL PART	MATERIJAL PO EN-u WERKSTOFF NACH EN MATERIAL ACC TO EN	MATERIJAL PO DIN-u WERKSTOFF NACH DIN MATERIAL ACC TO DIN
1	EN-GJS-500-7	GGG 50
2	EN-GJS-500-7	GGG 50
3	EN-GJS-500-7	GGG 50
4, 5	CC493K	CuSn7ZnPb
-	-	CuAl 8
-	X5CrNi 18-10	X5CrNi 18 10
-	-	NiFe 2
6	X20Cr13	X20Cr13
7	EN-GJS-500-7	GGG 50
-	CC484K	CuSn12 Ni
8	EN-GJS-500-7	GGG 50
-	CC493K	CuSn7ZnPb
9	EN-GJS-500-7	GGG 50
-	CC493K	CuSn7ZnPb
11	EN-GJL-250	GG 25
12	PTFE	PTFE
12	CC480K	CuSn 10
13	ARAMID	ARAMID
14	ARAMID	ARAMID
15	CC750S	CuZn33Pb
16	X20 Cr 13	X20 Cr13
17, 18	EPDM	EPDM
19	A2	A2

Ostali materijali na upit.
Andere Werkstoffe auf Anfrage.
Other materials on request.

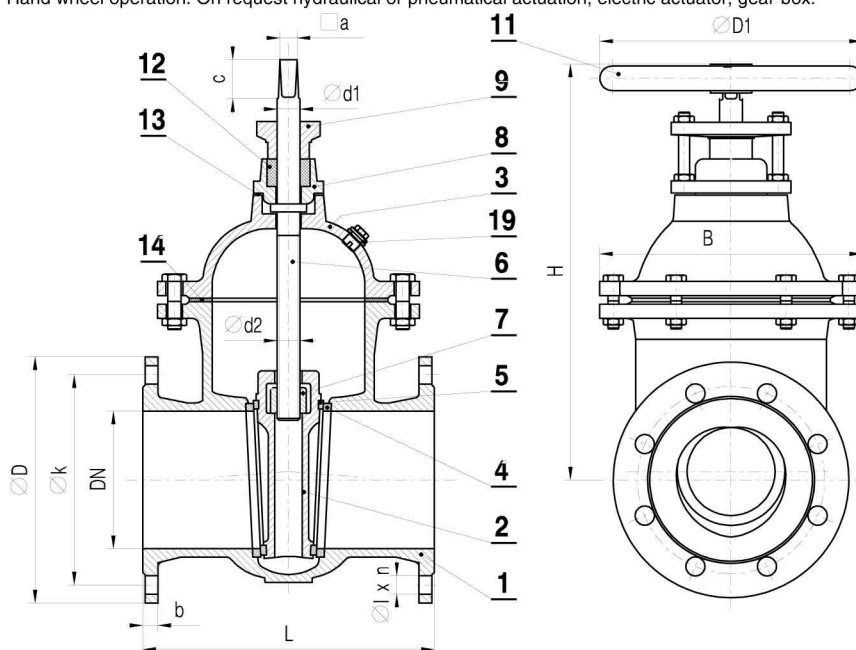

BRTVLJENJE
ABDICHTUNG
SEALING

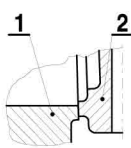

GGG /GGG

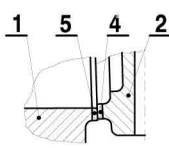

NIRO / NIRO
Bz / Bz

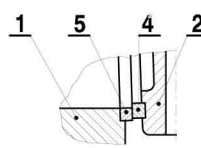

Ms / Ms
Bz / Bz

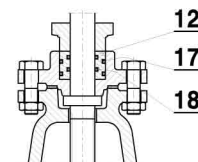

„O“ BRTVE
„O“ RING

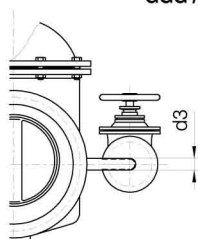

MIMOVD
UMFÜHRUNG
BYPASS

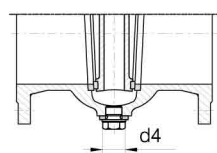

ČEP ZA ČIŠĆENJE
ENTLEERUNGSSCHRAUBE
DRAIN PLUG

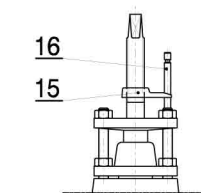

POKAZIVAČ OTVORENOSTI
ANZEIGEWERK
POSITION INDICATOR

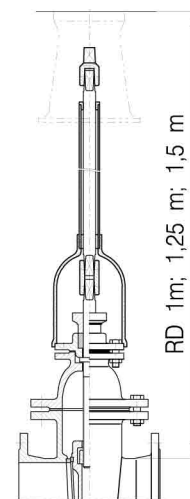

UGRADBENA GARNITURA
EINBAUGARNITUR
INSTALLATION EQUIPMENT

1m
RD 1,25m
1,5m