



NAZIVNI PROMJER NENNWEITE NOMINAL SIZE  <b>DN</b>	NAZIVNI TLAK NENNDRUCK PRESSURE RATING  <b>PN bar</b>	PRIRUBNICE FLANSCH EN 1092-2 (DIN 2501)  <b>bar</b>	VODNI ISPITNI TLAK WASSERPRÜFD RUCK TEST PRESSURE  <b>bar</b>		DOZVOLJENI RADNI TLAK KOD TEMPERATURE ZULÄSSIGER DRUCK BEI TEMPERATUR ADMISSIBLE PRESSURE AT TEMPERATURE	
			KUČIŠTE GEHAUSE BODY	ZATVORENO IM ABSCHLUSS CLOSED	TEKUĆINE DO 120°C	TEKUĆINE DO max 200°C
40 – 500	25	25	40	25	25	16

**Broj artikla  
Artikelnummer  
Model N°  
**V2 – 12****

NAMJENA: VODA, PITKA VODA, PLIN, PARA I VRELA VODA, NAFTA, ZRAK  
VERWENDUNG: WASSER, TRINKWASSER, GAS, DAMPF UND HEISSWASSER, ÖL, LUFT  
APPLICATION: WATER, DRINKING-WATER, GAS, STEAM AND BOILING WATER, OIL, AIR

**Ugradna mjera: EN 558-1 SERIJA 15 (DIN 3202 red F 5)**  
Baulängereihe: EN 558-1 SERIES 15 (DIN 3202 Reihe F 5)  
Face to face: EN 558-1 SERIES 15 (DIN 3202 Series F 5)

**ISPITIVANJE IZVRŠENO PREMA EN 12266 (DIN 3230)**  
FERTIGUNGSKONTROLLE NACH EN 12266 (DIN 3230)  
TEST ACCORDING TO EN 12266 (DIN 3230)

**Prirubnice izvedene za ugradnju prema EN 1092-2 (DIN 2501) ili na zahtjev prema DIMA 1882, UNI, BS, ANSI, NF**  
Einbaufansche nach EN 1092-2 (DIN 2501) oder auf Anfrage nach DIMA 1882, UNI, BS, ANSI, NF.  
Installation flanges according to EN 1092-2 (DIN 2501) or on request according to DIMA1882, UNI, BS, ANSI, NF

**Upravljanje ručnim kolom. Na zahtjev hidrauličko ili pneumatičko upravljanje, elektromotorni pogon, reduktor.**  
Handradbetätigung. Auf Anfrage hydraulische oder pneumatische Steuerung, Elektroantrieb, Reduktionsgetriebe.  
Hand wheel operation. On request hydraulic or pneumatical actuation, electric actuator, gear-box.

POZ TEIL PART	MATERIJAL PO EN-u WERKSTOFF NACH EN MATERIAL ACC TO EN	MATERIJAL PO DIN-u WERKSTOFF NACH DIN MATERIAL ACC TO DIN
1	EN-GJS-500-7	GGG 50
2	EN-GJS-500-7	GGG 50
3	EN-GJS-500-7	GGG 50
4, 5	CC493K	CuSn7ZnPb
	-	CuAl 8
	X5CrNi 18-10	X5CrNi 18 10
	-	NiFe 2
	CW 508 L	CuZn 37
6	X20Cr13	X20Cr13
7	EN-GJS-500-7	GGG 50
8	EN-GJS-500-7	GGG 50
	CC484K	CuSn12Ni
	CC493K	CuSn7ZnPb
9	EN-GJS-500-7	GGG 50
	CC493K	CuSn7ZnPb
11	EN-GJL-250	GG 25
12	PTFE	PTFE
12	CC480K	CuSn 10
13	ARAMID	ARAMID
14	ARAMID	ARAMID
15	CC750S	CuZn33Pb
16	X20Cr13	X20Cr13
17	EPDM	EPDM
18	EPDM	EPDM
19	A2	A2

Ostali materijali na upit.  
Andere Werkstoffe auf Anfrage.  
Other materials on request.

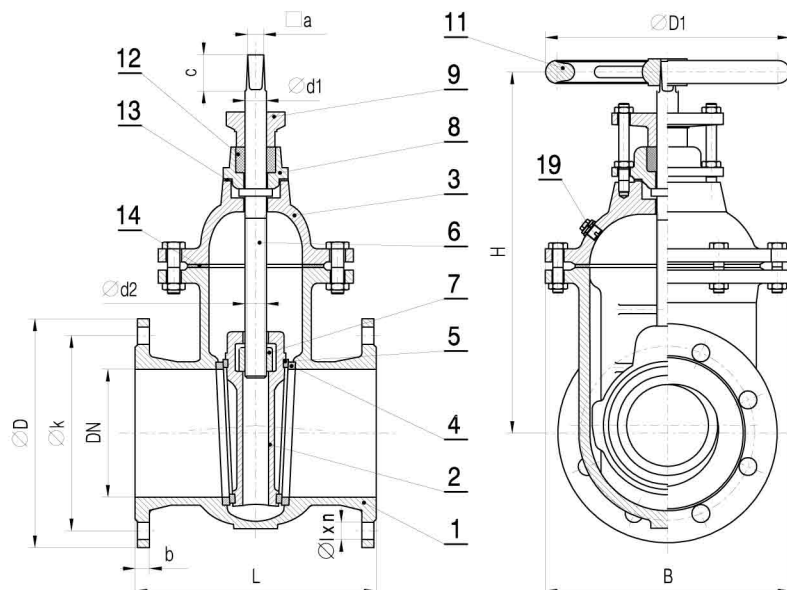

**BRTVLJENJE  
ABDICHTUNG  
SEALING**



**GGG /GGG**

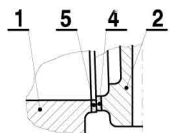

**NIRO / NIRO  
Bz / Bz**

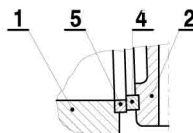

**Ms / Ms  
Bz / Bz**

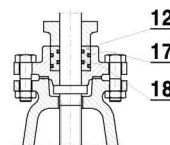

**„O“ BRTVE  
„O“ RING**

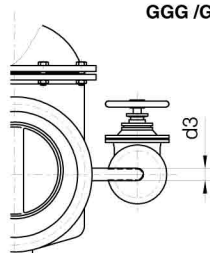

**MIMOVOD  
UMFÜHRUNG  
BYPASS**

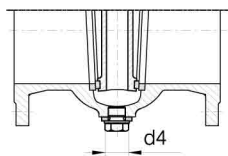

**ČEP ZA ČIŠĆENJE  
ENTLEERUNGSSCHRAUBE  
DRAIN PLUG**

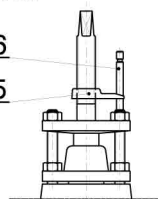

**POKAZIVAČ OTVORENOSTI  
ANZEIGEWERK  
POSITION INDICATOR**

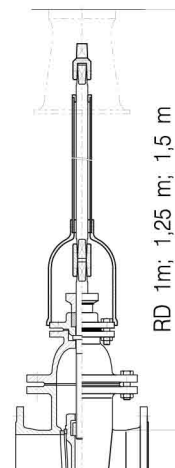

**UGRADBENA GARNITURA  
EINBAUGARNITUR  
INSTALLATION EQUIPMENT**

1m  
RD 1,25m  
1,5m